

**COLONY™ 5' x 30" WHIRLPOOL AND
BATHING POOL with INTEGRAL APRON**

- 2740.118 Whirlpool, Right Hand Outlet
- 2740.218 Whirlpool, Left Hand Outlet

Product Features:

- High Gloss Acrylic with fiberglass reinforcement
- Integral apron with removable access panel
- Integral three-sided, tiling/water retention flange
- Integral lumbar support
- Molded-in arm rests with elbow supports
- Above floor rough
- 1.25 HP single speed, self-draining pump/motor
- Six multi-direction jets
- One air volume control
- Deck mounted air switch On/Off control
- Factory installed and tested whirlpool system

EverClean™ Whirlpool Massage featuring System I

- 2740.218C Whirlpool featuring System I, Left Hand Outlet
- 2740.118C Whirlpool featuring System I, Right Hand Outlet
 - Same as above except with the EverClean™ whirlpool system featuring Antimicrobial AlphaSan®

- 2740.102 Bath only, Right Hand Outlet
- 2740.202 Bath only, Left Hand Outlet
 - Same as above without whirlpool system

Nominal Dimensions:

(59-7/8" x 29-7/8" x 19-1/4")
1521 x 759 x 489mm

Compliance Certifications -

Meets or Exceeds the Following Specifications:

- Underwriters Laboratories - Hydromassage Bathtubs UL 1795
- ASME A112.19.7M for Whirlpool Appliances
- ANSI Z124.1 for Plastic Bathtubs
- ASTM E162 for Flammability
- NFPA 258 for Smoke Density

SEE REVERSE FOR ROUGHING-IN DIMENSIONS
AND PRODUCT SPECIFICATIONS



To Be Specified - Required:

- Color:
- Bath Faucet: (specify finish)
- Bath Drain: 1583.470 (specify finish)

For color/finish availability and other faucet choices, please see the Product Selector and Pricing Guide.

COLONY™ 5' x 30" w/INTEGRAL APRON WHIRLPOOL & BATHING POOL
HIGH GLOSS ACRYLIC

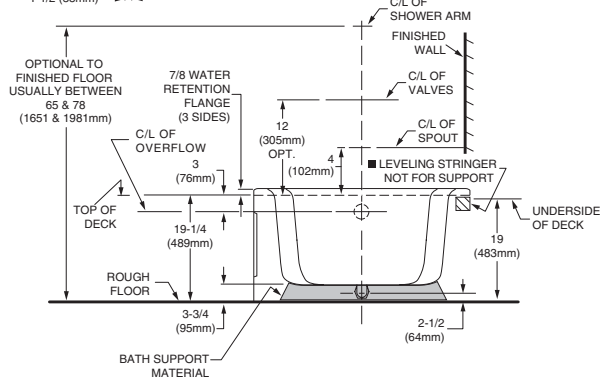
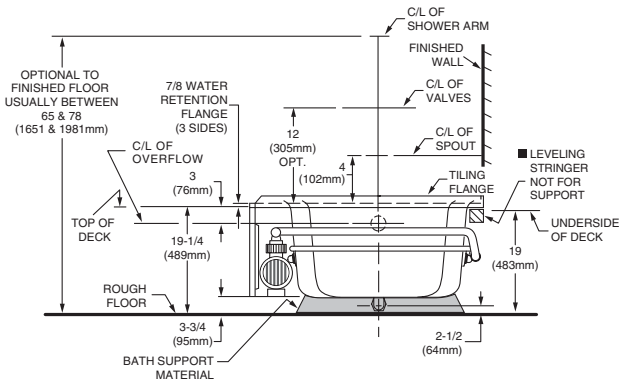
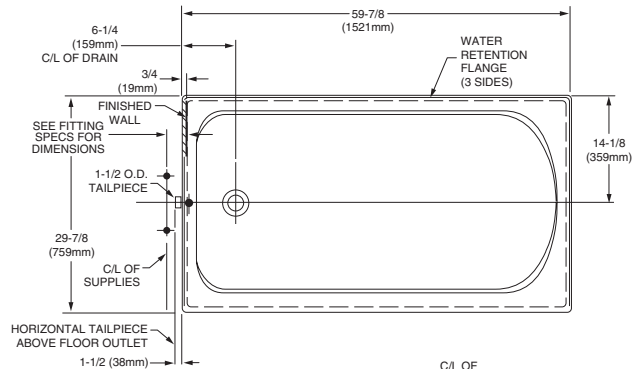
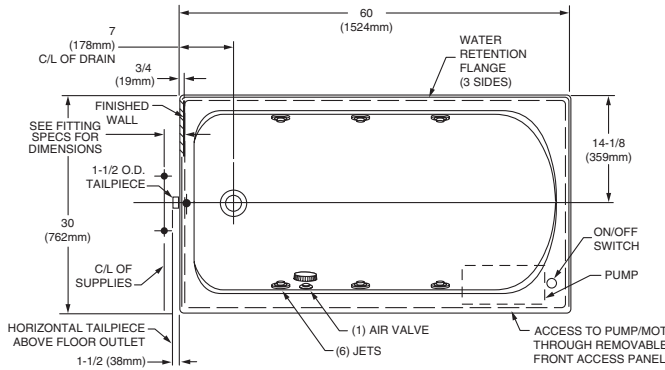

GENERAL SPECIFICATIONS FOR 2740 WHIRLPOOL	
INSTALLED SIZE	59-7/8 x 29-7/8 x 19-1/4 (1521 x 759 x 489mm)
WEIGHT	105 Lbs. (47 Kgs.)
WEIGHT w/WATER	480 Lbs. (216 Kgs.)
GAL. TO OVERFLOW	45 Gal. (171 L)
WHIRLPOOL MIN. OPERATING VOL.	38 Gal. (144 L)
BATHING WELL AT SUMP	20 x 46 (508 x 1168mm)
BATHING WELL AT RIM	25-1/2 x 55-1/2 (648 x 1410mm)
WATER DEPTH TO OVERFLOW	11-1/2 (292mm)
FLOOR LOADING (PROJECTED AREA)	39 Lbs./Sq.Ft. (188 Kgs./Sq.m)
PTS.	20.8
CUBE (FT ³)	35.3
WHIRLPOOL ELECTRICAL SPECIFICATIONS	
SYSTEM I PUMP	1.1 HP, 9.9 AMPS, 120V.

GENERAL SPECIFICATIONS FOR 2740 BATHING POOL	
INSTALLED SIZE	59-7/8 x 29-7/8 x 19-1/4 (1521 x 759 x 489mm)
WEIGHT	70 Lbs. (32 Kgs.)
WEIGHT w/WATER	462 Lbs. (208 Kgs.)
GAL. TO OVERFLOW	47 Gal. (178 L)
BATHING WELL AT SUMP	20 x 46 (508 x 1168mm)
BATHING WELL AT RIM	25-1/2 x 55-1/2 (648 x 1410mm)
WATER DEPTH TO OVERFLOW	11-1/2 (292mm)
FLOOR LOADING (PROJECTED AREA)	37 Lbs./Sq.Ft. (179 Kgs./Sq.m)
PTS.	20.8
CUBE (FT ³)	35.3

NOTES:

BATH TO BE INSTALLED ABOVE FLOOR LINE AS A RECESS INSTALLATION.

■ REFER TO INSTALLATION INSTRUCTIONS SUPPLIED WITH WHIRLPOOL FOR ADDITIONAL INFORMATION.

BATH TO BE INSTALLED ABOVE FLOOR LINE AS A RECESS INSTALLATION.

LEFT HAND OUTLET SHOWN, RIGHT HAND REVERSE DIMENSIONS (2740.118).

FITTINGS NOT INCLUDED AND MUST BE ORDERED SEPARATELY.

PROVIDE SUITABLE REINFORCEMENT FOR ALL SUPPORTS.

IMPORTANT: Dimensions of fixtures are nominal and may vary within the range of tolerances established by ANSI Standards Z124.1 and A112.19.7. These measurements are subject to change or cancellation. No responsibility is assumed for use of superseded or voided pages.